

AQUARIUS

BCDMH Briquette Feeders

Pressure Rated
Feeders for the
Controlled
Dissolution of
BCDMH - Bromine
Tablets or Briquettes

- ✓ Pressure Rated to 280 kPa.(BCD12 & 33)
- ✓ Pressure Rated to 500 kPa. on BCD100
- ✓ Large Capacity - 100 Kgs, 34 Kgs. or 13Kgs.
- ✓ Floor Mounting for ease of refilling
- ✓ Wide 225 mm lid for easy refilling
- ✓ Bottom drain valve for ease of refilling

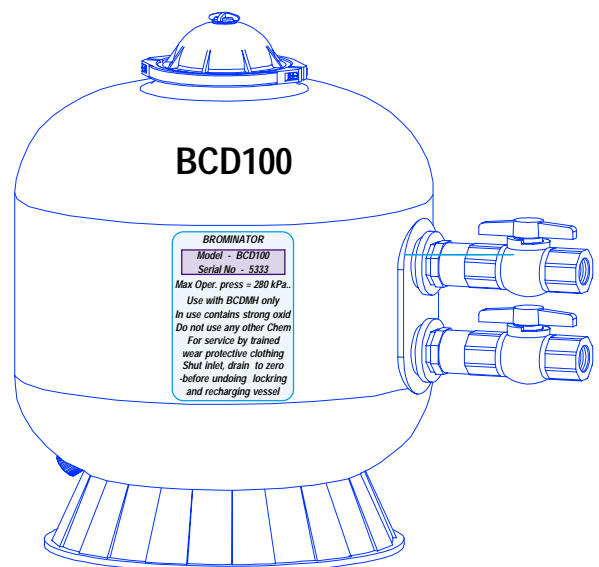
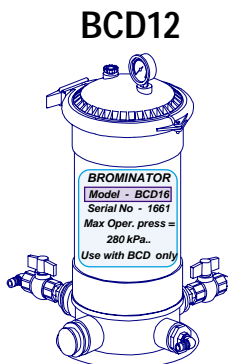

ADVANCED TECHNOLOGY FOR THE NEW MILLENIUM

Aquarius BCDMH Briquette Feeders

TECHNICAL DESCRIPTION

The Aquarius Models BCD12, BCD33 and BCD100 are pressure rated feeders re-engineered from polyester cartridge or filter housings to provide for automatic dissolution of BCDMH - Bromo-chloro-dimethylhydantoin tablets or briquettes.

When coupled with an DR100FV - ORP controller or, pH & ORP controllers, or Conductivity & ORP controllers, these units allow for the dissolution and automatic proportional dosage of the bromine based biocide, based on demand from the system.

BCDMH bromine based organic briquettes or tablets provide for superior sanitation of cooling systems, swimming pools, spa's, hydrotherapy pools and ornamental fountains and the maintenance of a small residual of oxidant normally provides for excellent protection from Legionnaires Disease Bacteria, or other pathogenic bacteria, in the system.

Maintenance of a low residual by means of a ORP sensor ensures that dosage is automatically carried out to maintain that residual, even under fluctuating load conditions, and without excessive dosage of products which can cause severe corrosion to metals in the system.

All BCDMH models are designed as up flow deep bed leaching devices, which operate under turbulent flow conditions to ensure high dissolution rates of BCDMH product, and are flooded beds to ensure the BCDMH product is always under water and minimises any danger of ignition from damp or partially wet oxidising agent.

Dissolution rate of most types of BCDMH products depend on bed depth, water temperature, and water flow rate through the bed. The specifications later in the bulletin give typical dissolution rates, and usage rates for various size systems.

When coupled with the ORP Controller models - these systems provide for automatic dosage and control.

The feeder capacity should allow for in excess of 30 days supply on cooling systems or fountains, and in excess of 7 days on large swimming pools, before recharging

On very large systems, two off of the BCD100 units can be installed in series to ensure sufficient supply is always at hand.

These feeders are intended for use with Bromo-chloro-dimethylhydantoin based tablets or briquettes ONLY and using the system circulating water ONLY as the dissolving water source for the vessel.

FEATURES

- * Corrosion Resistant Polyester & PVC
- * Large Capacities - 13, 33, or 100 Kgs.
- * Floor mounting - Easy to Refill
- * Floor mounting - Safety when refilling
- * Easy to undo Lock Ring for refilling
- * Wide 225 mm lid for ease of refilling
- * Pressure Gauge & Rating to 280 kPa.
- * Air Bleed Valve for rapid drain down
- * Bottom drain valve to facilitate refilling

SPECIFICATIONS

	BCD100	BCD33	BCD12
Capacity of BCD - Kgs.	100	34	13
Typical Flow Rate - lts/min	50	10	10
Max Flow Rate - lts/min	100	20	20
Max Pressure Rating - kPa..	500	280	280
Plumbing - BSP inlet & outlet	50	15	15
Plumbing - Pressure hose	50	13	13
Typical Dissolution Rate - kgs/hr	1.5	0.3	0.3

APPLICATIONS

- ✓ Cooling Towers
- ✓ Swimming Pools
- ✓ Water Features
- ✓ Hydrotherapy Pools
- ✓ Ornamental Fountains
- ✓ Vegetable Disinfection Flumes
- ✓ Vegetable Disinfection Spray Systems

SIZING of the BCD FEEDER for Cooling Towers

A typical usage rate of BCDMH on cooling towers is approximately 20 gms. per hour per 1000 kWR, system capacity and the capacity of the feeder required can be calculated from the following formula:-

$$\text{Capacity in Kgs.} = \frac{\text{kWR} \times \text{hrs./day} \times \text{days supply}}{50000}$$

e.g. a 3000 kWR total capacity, plant operates 12 hrs./day and 40 days supply (between service visits - and allowing for maximum load in summer) equals:-

$$\frac{3000 \times 12 \times 40}{50000} = 28.8 \text{ Kgs.}$$

= min. capacity for 40 days supply - select the BCD33 unit (34 Kgs. which should give approx. 40 days supply at maximum load.)

NOTE that the average consumption or chemical usage per year will usually be much less than that above which is sized to allow for maximum load.

Aquarius BCDMH Briquette Feeders

Typical Capacities of Feeders

	Feeder	System Capacity	Storage Capacity
Cooling Water Systems	BCD12	1000 kW - Continuous Load	30 days
Cooling Water Systems	BCD33	3000 kW - Continuous Load	30 days
Cooling Water Systems	BCD100	10,000 kW - Continuous Load	30 days
Swimming Pool or Water Features	BCD12	300 m ³ - System Volume	7 days
Swimming Pool or Water Features	BCD33	1000 m ³ - System Volume	7 days
Swimming Pool or Water Features	BCD100	3000 m ³ - System Volume	7 days
Ornamental Fountains	BCD12	50 m ³ - System Volume	30 days
Ornamental Fountains	BCD33	150 m ³ - System Volume	30 days
Ornamental Fountains	BCD100	500 m ³ - System Volume	30 days
Vegetable Flumes	BCD12	10 m ³ - System Volume	24 hours
Vegetable Flumes	BCD33	30 m ³ - System Volume	24 hours
Vegetable Flumes	BCD100	100 m ³ - System Volume	24 hours
Vegetable Spray Systems Recirculating	BCD12	5000 lts/hr - Spray Volume	24 hours
Vegetable Spray Systems Recirculating	BCD33	15000 lts/hr - Spray Volume	24 hours
Vegetable Spray Systems Recirculating	BCD100	50000 lts/hr - Spray Volume	24 hours

Schematic Installation of a BCDMH Feeder on a Flume

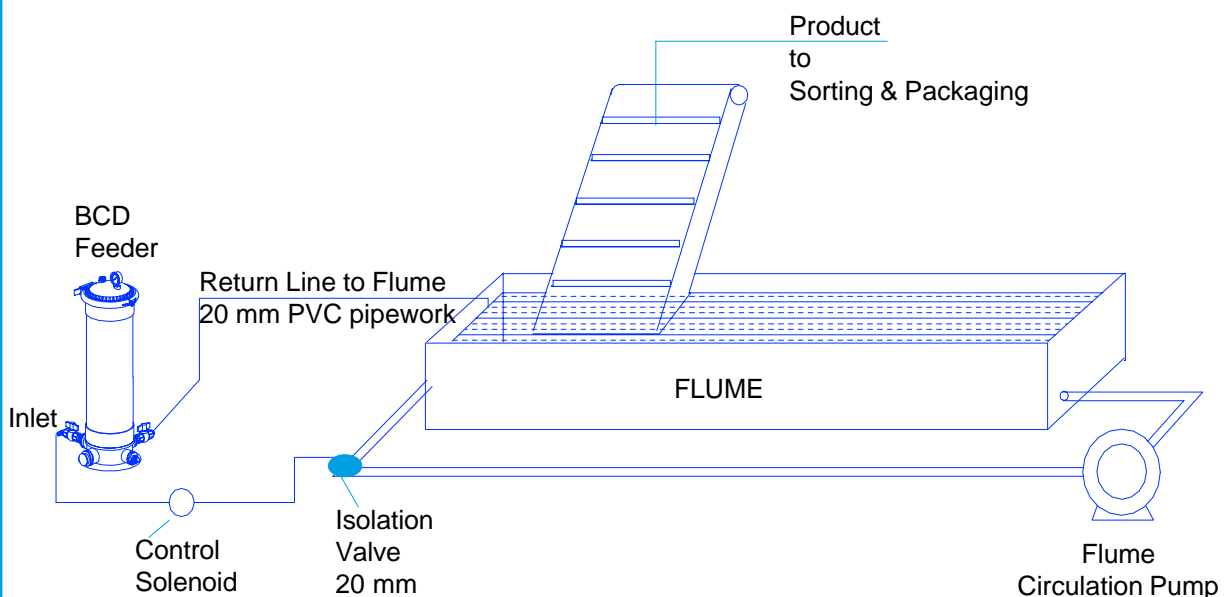

Aquarius BCDMH Briquette Feeders

ON-SITE ASSEMBLY OF BCD33 & BCD16 FEEDERS

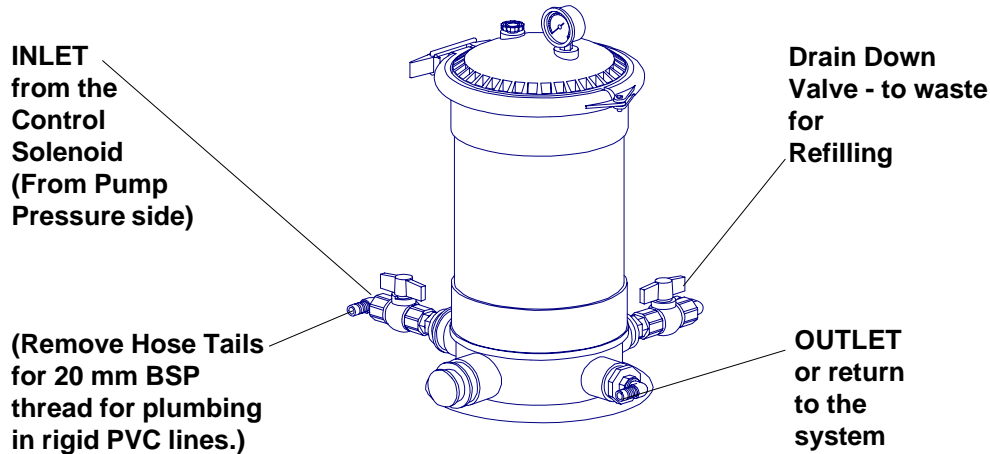

BCD16 & BCD33 ASSEMBLY GUIDELINES

1. The feeders should preferably be installed in an area to ensure adequate ventilation from any fumes when refilling.
2. The feeder should be installed on a concrete slab or concrete tile minimum 300 x 300 mm and at floor or ground level for ease of refilling.
3. Screw the inlet and drain valve sections into the **IN** ports of the feeder and the outlet hose tail to the **OUT** port of the feeder. The drain valve should point to the back of the feeder and be parallel with the floor when fixed.
4. Seat the large "O" ring around the lid groove, screw the pressure gauge into the lid, seat the lid on top of unit ensuring the large "O" ring is in place, and clamp the lid in place.
5. The unit is now ready for locating on concrete slab or tile prior to commencement of plumbing in & out of vessel.
6. Ensure that there is approx. 500 mm of free space above the lid to allow for ease of refilling the vessel.
7. Ensure that there is approx. 100 mm clearance all around the vessel to facilitate removal of the lid and the lock ring when refilling the unit.
8. Refer to next page for plumbing guidelines, and commissioning instructions.

ON SITE ASSEMBLY OF BCD100 FEEDER

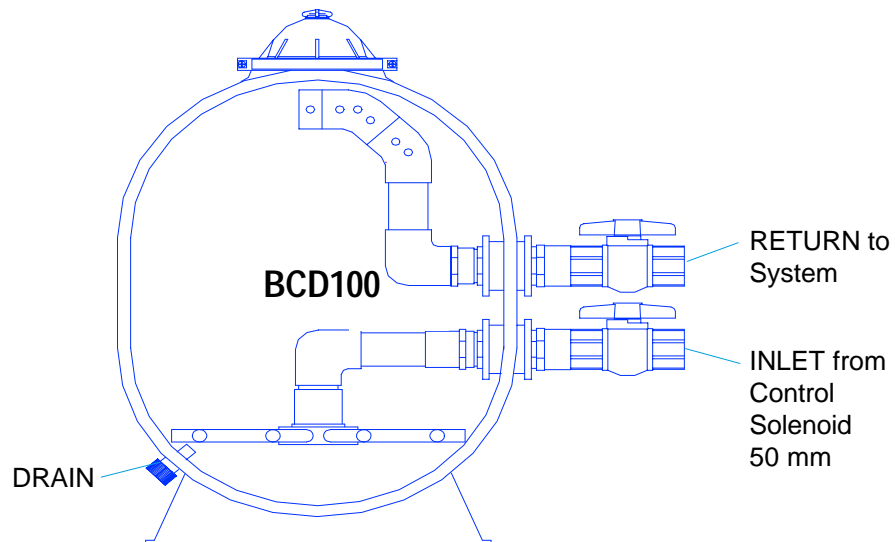

1. Attach the 50 mm valves supplied as shown in the diagram above.
2. Plumb to and fro the unit in 50 mm PVC pipework utilising a 50 mm control solenoid.
3. Secure the O-ring on top opening and attach the lid.
4. Fill system with water and check for leaks.
5. Drain down the vessel and proceed to fill unit with BCDMH tablets up to level with the top internal offtake pipe.
6. Clean around the opening and the O-ring and replace the lid, and return unit to service.

Aquarius BCDMH Briquette Feeders

Schematic Installation of a BCDMH Feeder on Cooling Towers

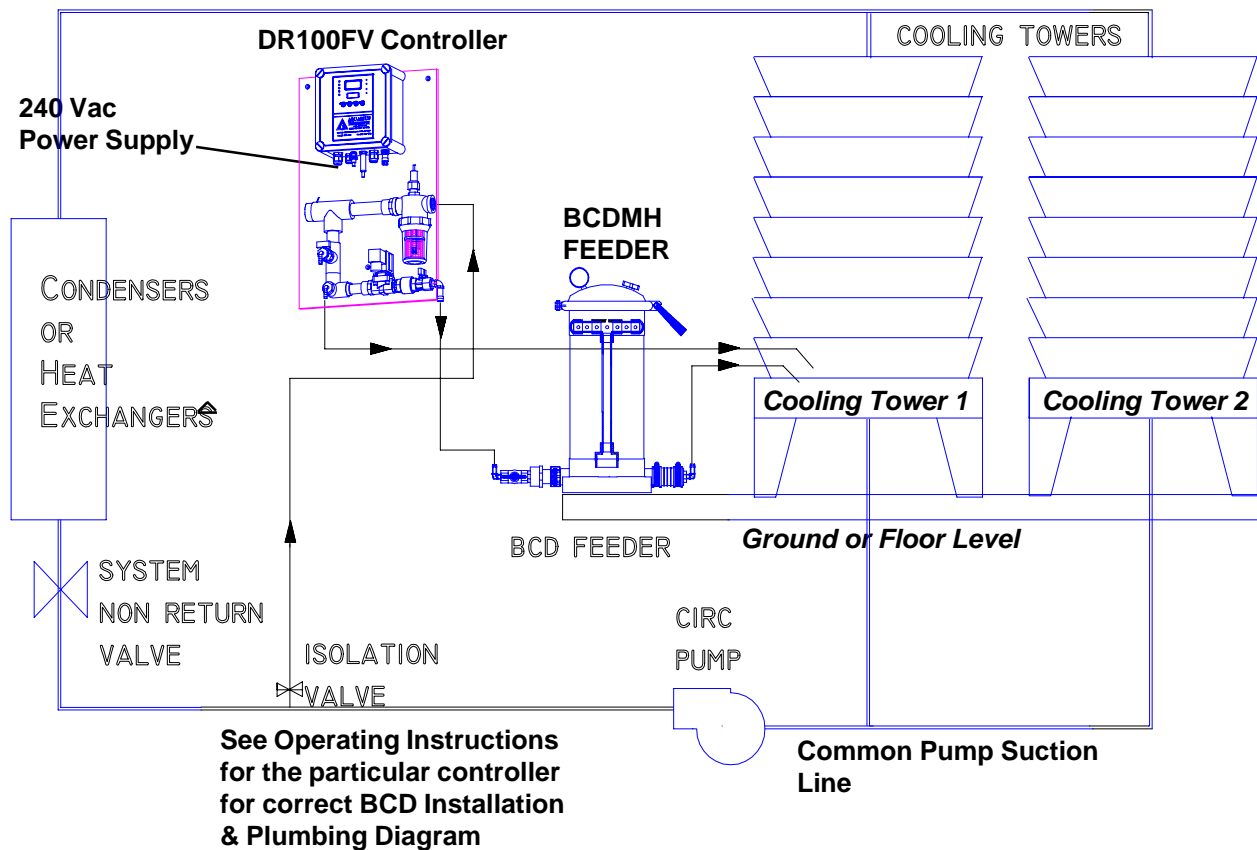

Installation Guidelines

1. The pH and ORP controllers house sensitive electronics and preferably should be installed internally in the plant room, or if external should be installed in shade and protected from direct sunlight and temperature extremes.
2. The BCDMH feeders should preferably be installed outside in close proximity to the cooling towers or in large well ventilated plant rooms.
3. Plumbing as in diagram above can be in uPVC pipe utilising the 20 mm. BSP threads after removal of any hose tails.
4. Plumbing can also be carried out using braided pressure 19 mm hose and utilising the hose tails supplied.
5. **The outlet of the BCD feeder will contain high levels of oxidising agent which would be corrosive to copper, S/S, and mild steel pipework. Plumbing from the feeder should be in corrosion resistant pipe or hose and directed to an area of good mixing in the cooling tower basin. e.g. vicinity of make up water to tower basin.**
6. **Care should be taken that the take off point to the Controller is before the system Non - Return valve to avoid short circuiting the non-return and overflowing the system on plant shutdowns.**
7. Refer to the actual Controller operating instructions for commissioning instructions for the controller.

Recharging the BCD Feeders

Refer to safety instructions for the particular brand of BCDMH chemical, Read and understand the MSDS sheet supplied with the chemical, Wear the appropriate safety gear. Refer to the safety guidelines printed on the feeder.

BCDMH chemicals are strong oxidising agents and can cause fire or explosion if mixed with other chemicals !! Ideally your feeder should be recharged by a trained water treatment specialist as follows :-

1. Isolate the inlet valve to the BCD feeder.
2. Open the drain valve to drain down feeder.
3. Open the air bleed valve to assist drain down.
4. When pressure gauge registers zero undo the lock ring and remove lid.
5. Refill container with BCDMH tablets or briquettes up to the Tee take off only. Do NOT OVERFILL
6. Clean off the "O" ring and lid seat, and replace lid.
7. Fit the lock ring and clamp the lid in place.
8. Shut the drain valve, and open the isolation valve and allow the vessel to fill with water.
9. Shut the air bleed valve when vessel is full and water exits at the air bleed.
10. Activate the solenoid, and check that there is sufficient flow through the feeders to the towers.

Aquarius BCDMH Briquette Feeders

Schematic Installation of a BCDMH Feeder on Swimming Pool

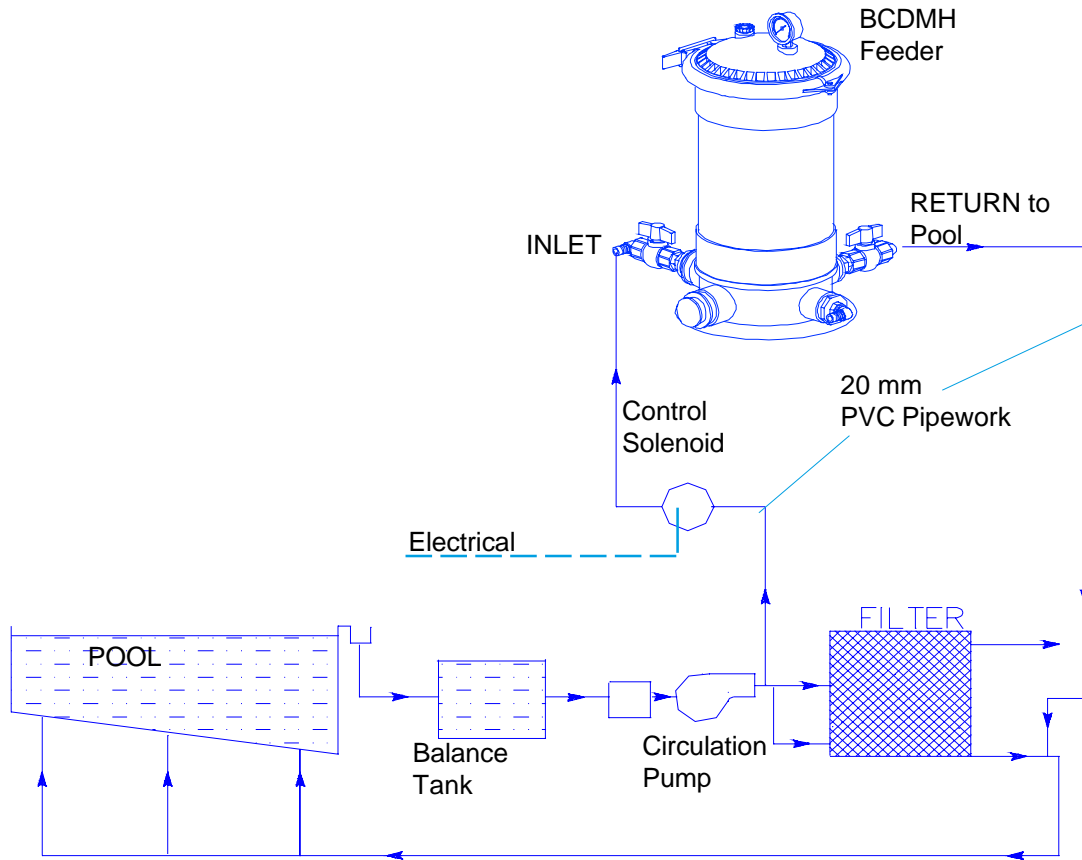

This Space Intentionally Blank !

Aquarius BCDMH Briquette Feeders

MANUFACTURER'S PRODUCT WARRANTY

AQUARIUS TECHNOLOGIES PTY. LTD. manufactures a range of equipment under a Quality Assurance system to ISO9001:1994 standards and warrants equipment of its manufacture to be free of defects in material or workmanship.

Liability under this policy extends for 12 months from the date of installation, or 24 months from the date of shipment from our factory, whichever ever occurs first. The manufacturer's liability is limited to repair or replacement of any failed equipment or part of, which is proven to be defective in material or workmanship upon the manufacturer's examination. This warranty does not include removal or installation costs and in no event shall the manufacturer's liability exceed its selling price of such equipment or part.

Aquarius Technologies Pty Ltd. disclaims all liability for damage to its products through improper installation, maintenance, use or attempts to operate such products beyond their functional capacity, intentionally or otherwise, or any unauthorised repair. Aquarius Technologies Pty Ltd. will not be responsible for any consequential or other damages, injuries, or expense incurred through use of its products.

This warranty is in lieu of any other warranty, either expressed or implied. Aquarius Technologies Pty Ltd. make no warranty of fitness or merchantability. No agent of ours is authorised to provide any warranty other than above.

This warranty does not exclude any condition or warranty implied by the Trade Practices Act 1974 or separate State Laws in Australia and is in addition to any other right that the original purchaser or any subsequent purchaser may have under Australian law.

Should a unit fail to function normally, please contact our Customer Service Department by phone or fax quoting, Model Number, and Serial Number, for initial discussion of the problems encountered, and if it is necessary to return the item to the factory, a Return Authorisation number will be given to facilitate return, and repair or replacement of the item.

The item for return should be carefully packaged to prevent any damage in transit, contain the Return Authorisation identification number, customer identification, and return delivery details, and the freight prepaid to our factory. If in the opinion of our factory, after examination, the failure was due to materials or workmanship, repair or replacement will be made with out charge for parts, labour and return freight. A reasonable service charge will be made for diagnosis and/or repairs due to normal wear, abuse, tampering or damage in transit.

AQUARIUS TECHNOLOGIES PTY Ltd. reserve the right to continue development and improvement of the entire range of our equipment, and therefore minor changes may occur due to these improvements and the continuing development.

